

Motorized Alternating Valve

Installation Guide for EE and EI



V3069FF • 1" and 1.25"



V3069MM • 1" and 1.25"



V3071 or V3071BSPT
1.5"



V3076 or V3076BSPT
2"

M.A.V. Installation Guide

V3069FF 1" and 1.25"



V3069MM 1" and 1.25"



View from top



"A" Port

"B" Port

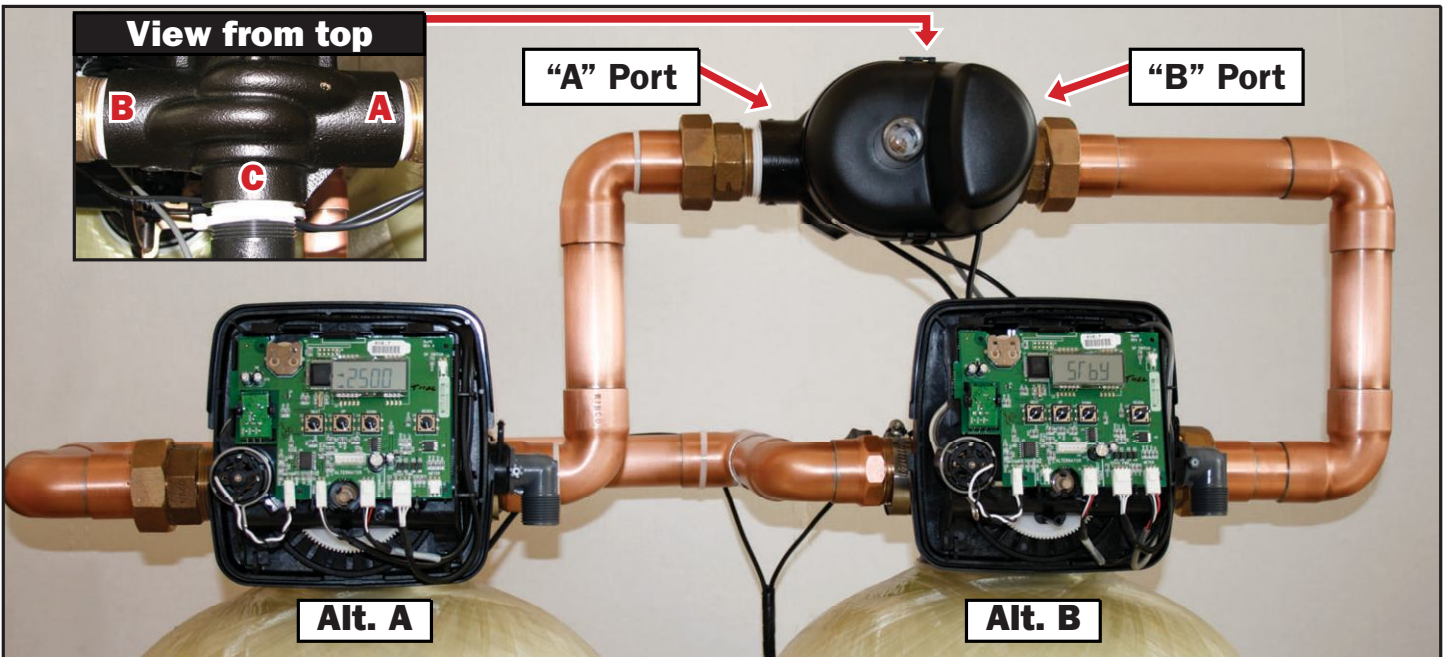

Alt. A

Alt. B

OPERATING PRESSURES: 20 PSI MINIMUM / 125 PSI MAXIMUM • OPERATING TEMPERATURES: 40°F MINIMUM / 110°F MAXIMUM

1. Plumb the Motorized Alternating valve according to the photo and drawing attached.
NOTE: The Control Valve connected to the "A" port on the Motorized Alternating Valve must be designated "Alt A" during programming. The Control Valve connected to the "B" port on the Motorized Alternating Valve must be designated "Alt B" during programming.

M.A.V. Installation Guide

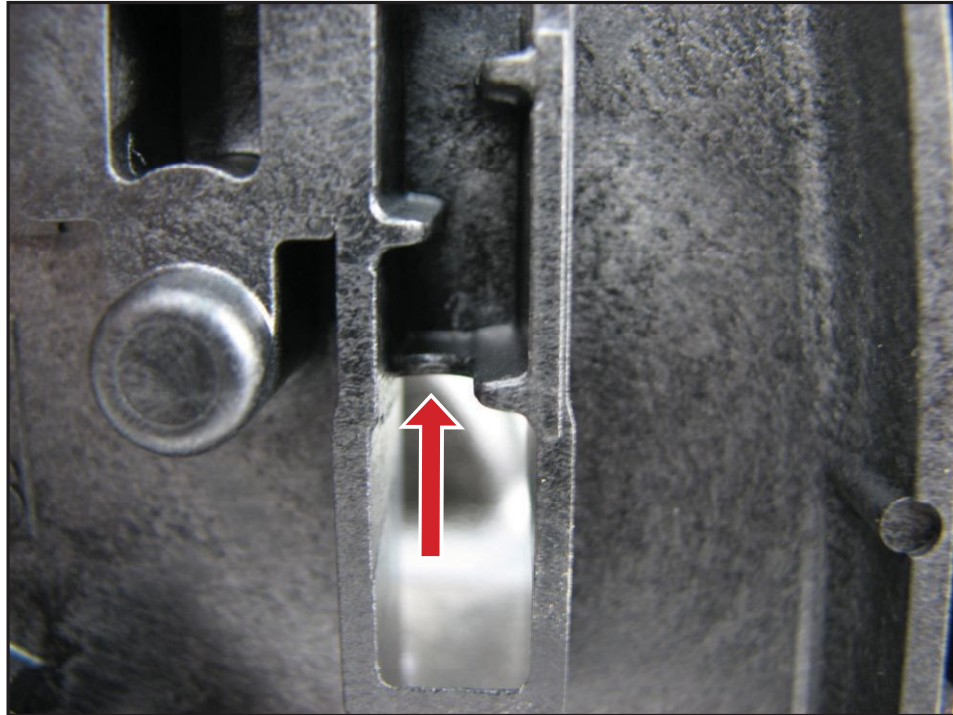

Prior to connecting the meter, motorized alternating valve, and interconnect cable, it is necessary to break off the two plastic tabs, on the control designated as “Alt A” and one plastic tab, on the control designated as “Alt B”.

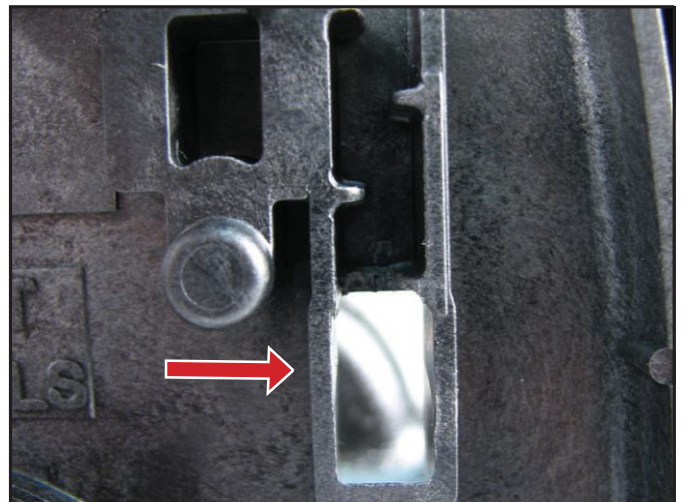
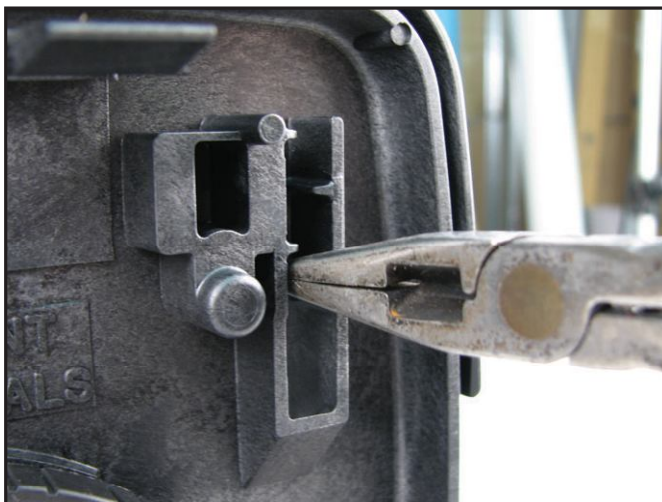

2. With needle nose pliers break off the plastic tabs on each side of the back plate. When tabs are removed you are now able to run two wires through each side of the back plate.

M.A.V. Installation Guide

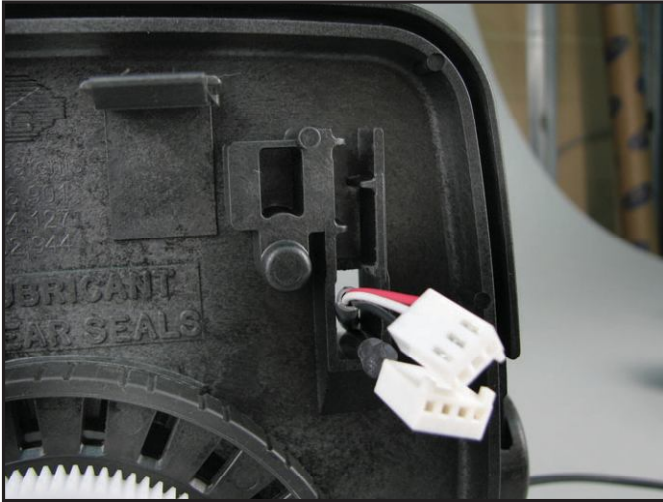

3. Route the wires through the back plate and weave them through the retainer. Allow about one foot of cable through the back plate to allow for connection to PC Board.

Alt. A



4. The 8' alternator valve motor cable must be connected to the two pin connector labeled **DRIVE** on Control Valve Alt. "A".

M.A.V. Installation Guide

Alt. A

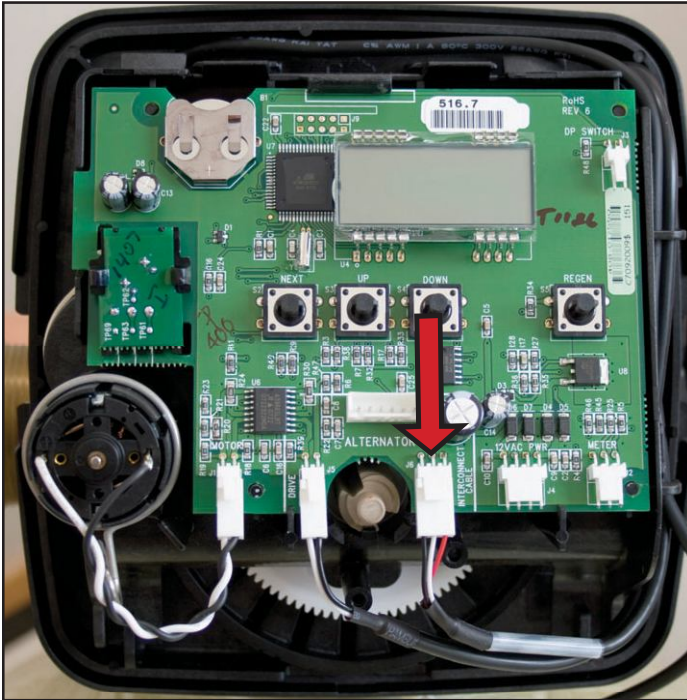

Alt. B



5. Connect each end of the 8' alternator interconnect cable to the three pin connector labeled **INTERCONNECT CABLE**, on both Control Valve Alt. "A" and Control Valve Alt. "B".

NOTE:

SINGLE METER APPLICATIONS: When using a single meter (typically 1.5" and 2") with the motorized alternating valve it is necessary to use a three wire interconnect cable P/N V3474 between the control valves. The black wire (the one closest to the cut out on the circuit board) is used to send the meter signal to the other control valve.

DUAL METER APPLICATIONS: When using two meters one on each control valve it is necessary to use a two wire interconnect cable P/N V3474-01 between the control valves. The black wire (the one closest to the cut out on the circuit board) is removed being each control receives its own meter signal. Using a three wire interconnect cable with dual meters will cause the controls to go into an ERROR. A three wire interconnect cable could be used on a dual meter application by removing or cutting the black wire (the one closest to the cut out on the circuit board) from the three wire pin connector.

M.A.V. Installation Guide

Alt. B

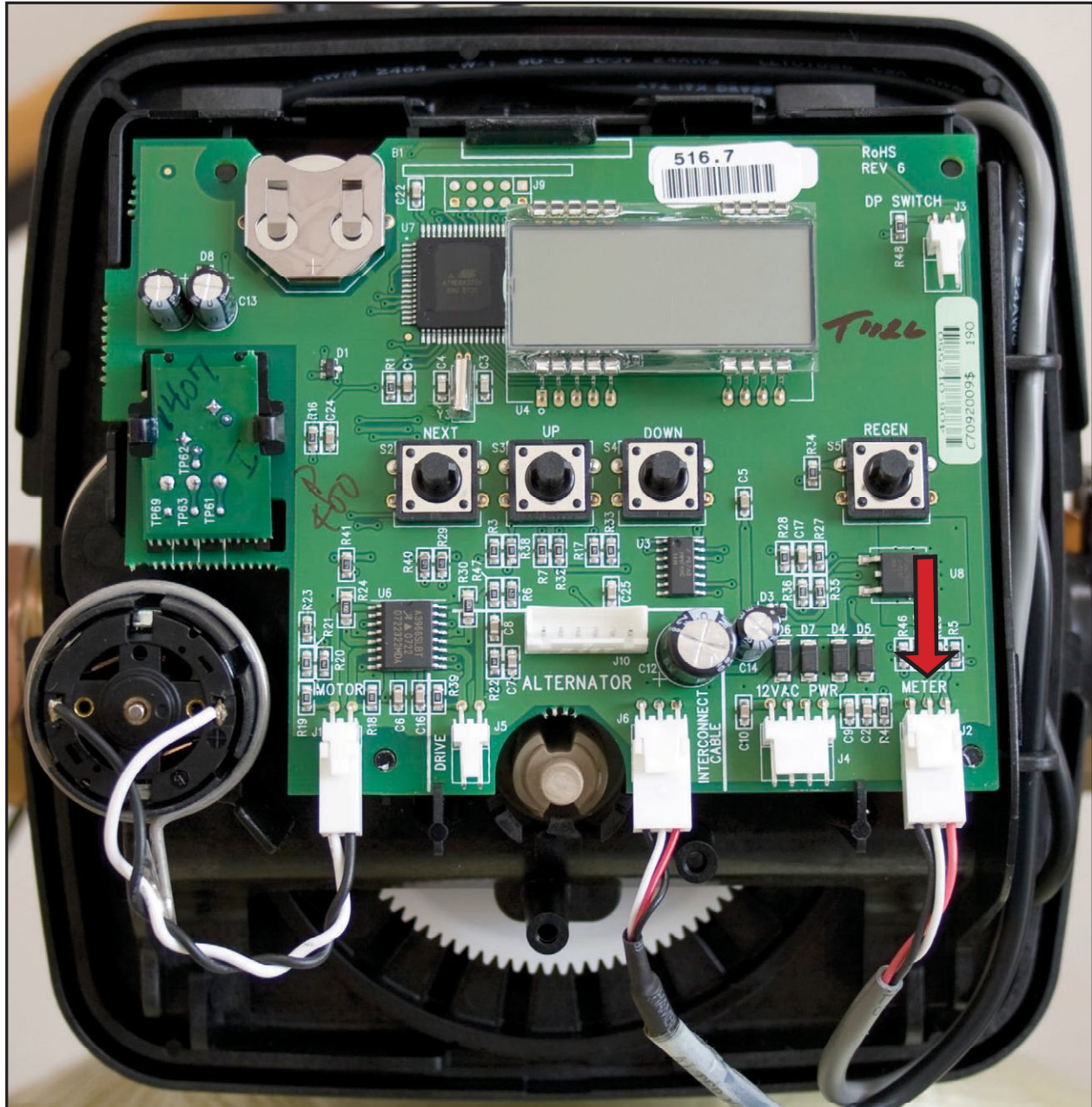

6. **SINGLE METER APPLICATIONS:** Connect the 15' water meter cable to the three pin connector labeled **METER** on either Control Valve Alt. "A", or Control Valve Alt. "B". **NOTE: Due to the number of wires coming through the back plate, this connection can be made more easily on Control Valve Alt. "B".**

DUAL METER APPLICATIONS: Connect the water meter cable to the three pin connector labeled **METER** on both Control Valves.

M.A.V. Installation Guide

Alt. A

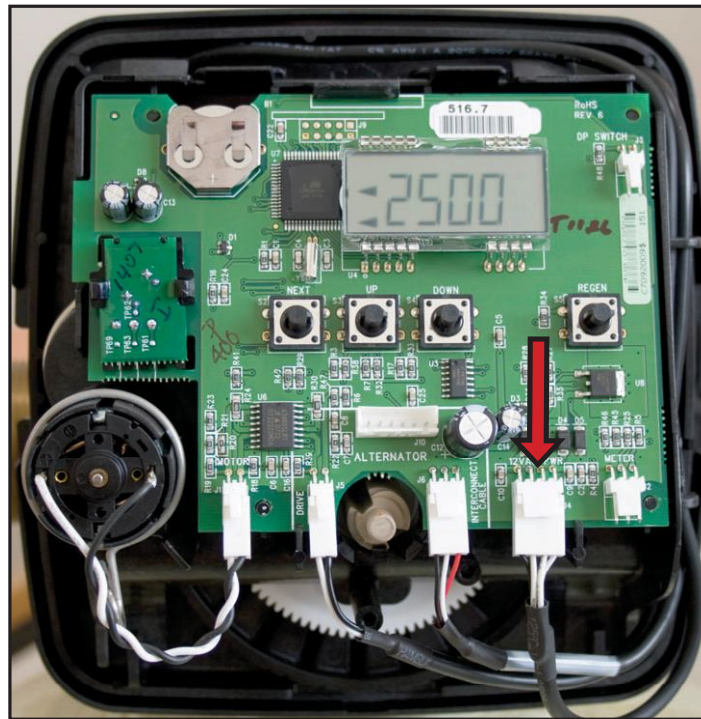

Alt. B



7. Connect the power cable to both of the four pin connectors labeled **12VAC PWR** on Control Valve Alt. "A" and Control Valve Alt. "B". The control valve will now be ready for programming.

